



JCI
Choice Series
AD28

8737 AL Hwy 51
Opelika, AL 36804
Ph: (334)826-9538
Fax: (334)826-9539

Project Name: _____

Delivery Zip Code: _____

Standard Features

- Welded or knock down 18ga G90 galvanized steel construction
- 14 inches high
- Factory installed PT 1x4 wood nailer
- Supplied 1-1/2x1/4" closed cell neoprene gasket

Options (please check):

- Heavier gauge metal
- 5052-H32 AL or 304 SS construction
- Custom height
- Horizontal duct connections*
- Turning vane*
- 1" or 2" isolation rails
- Seismic rating/stamp
- Wind rating/stamp
- Filtration*
- Metal Building construction*
- Insulated
- Other per customer specs

* Welded curb only

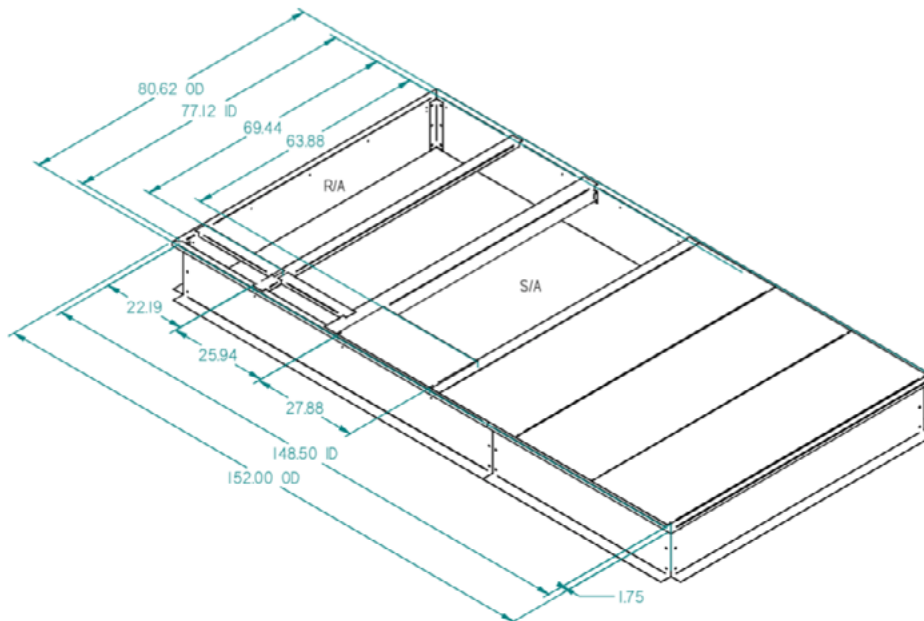

Quantity	Weld/KD	Height	Options	Special Notes